

Possible power sources:  
wahlweise

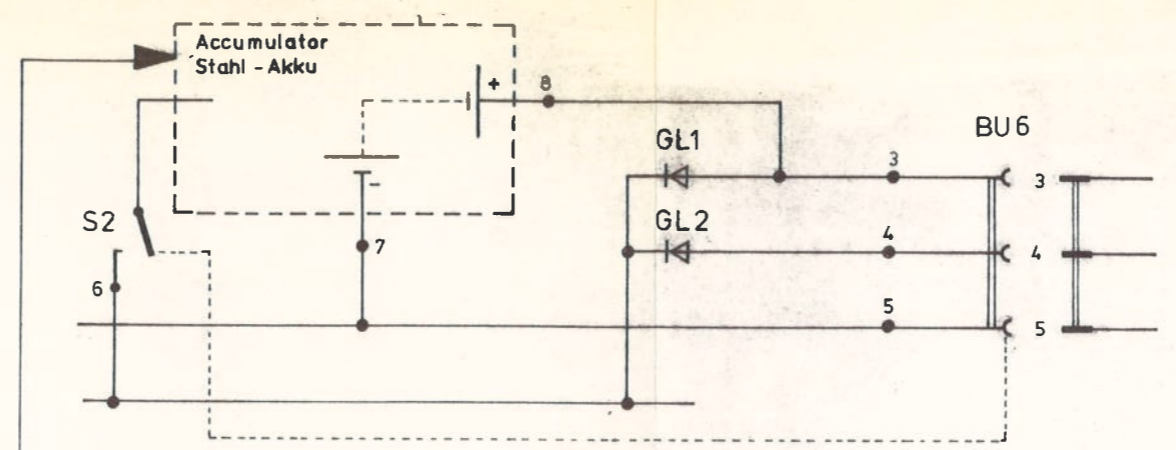

Netz - Ladegerät  
Power pack &  
battery charger

Netz / AC supply

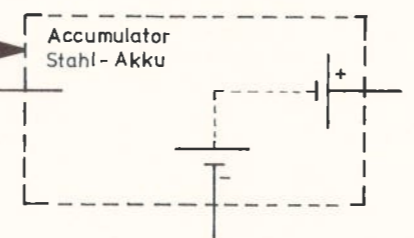
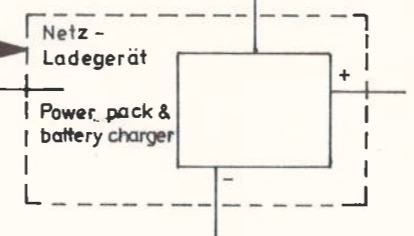

Grundausrüstung  
Basic version

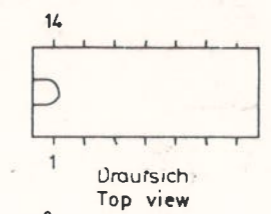
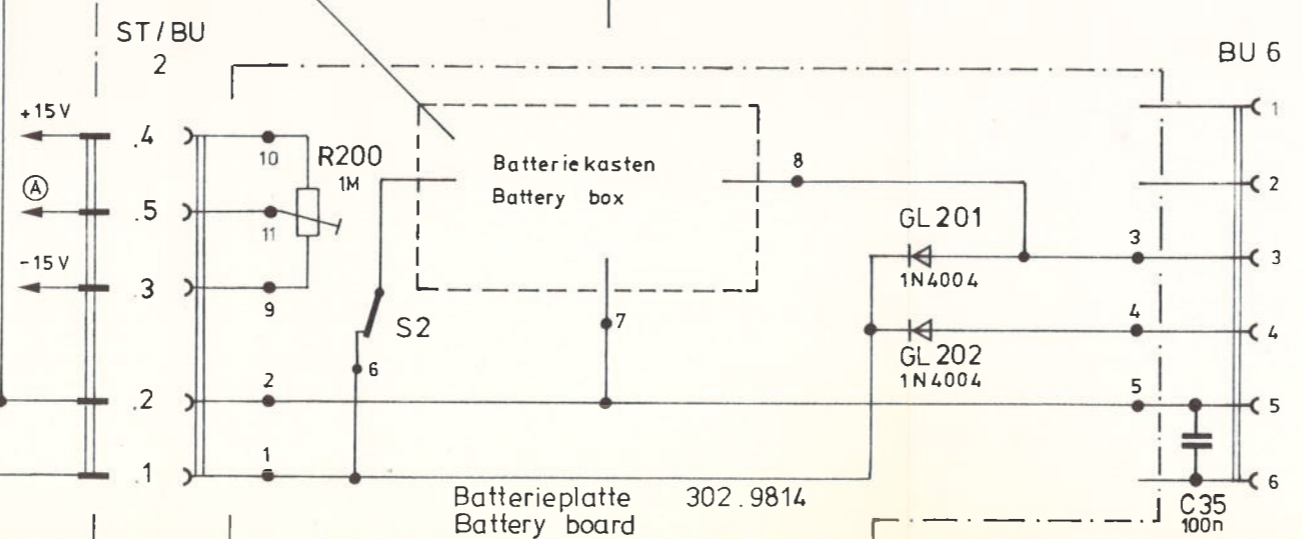
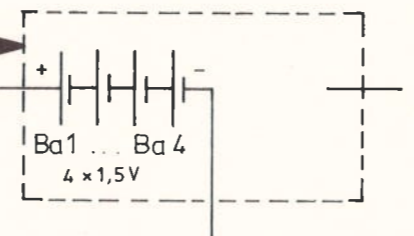

B2, B3, B10, B11, B17, B19

Draufsicht  
Top view

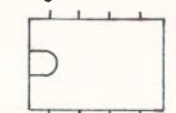

B1, B12, B13, B18

Draufsicht  
Top view



T3, T4

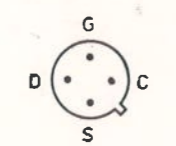

T1, T2

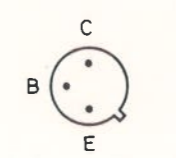

T5 - T21

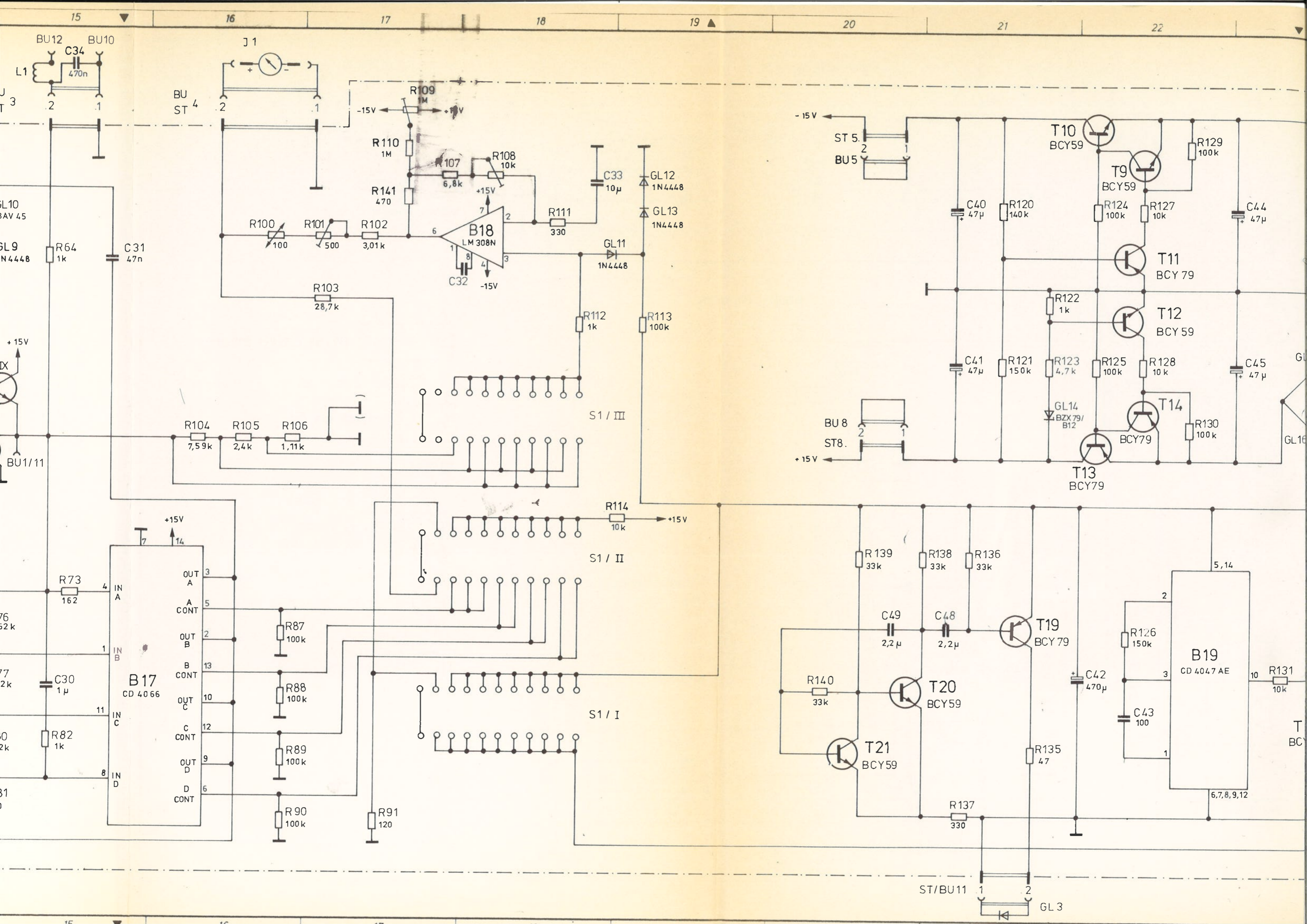

15

16

17

18

19

20

21

22

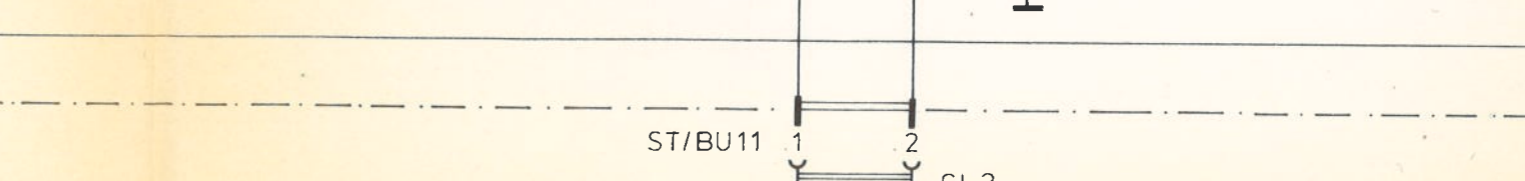
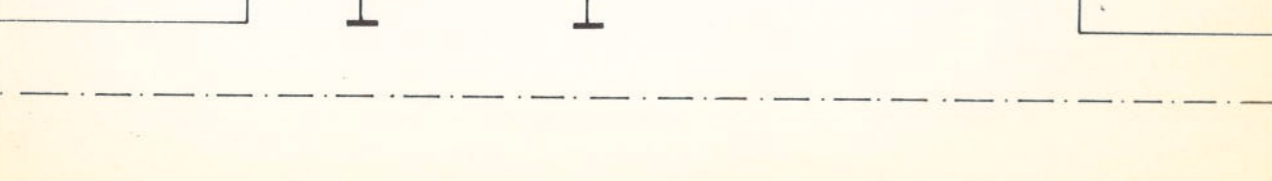
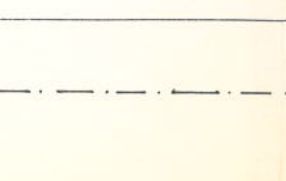
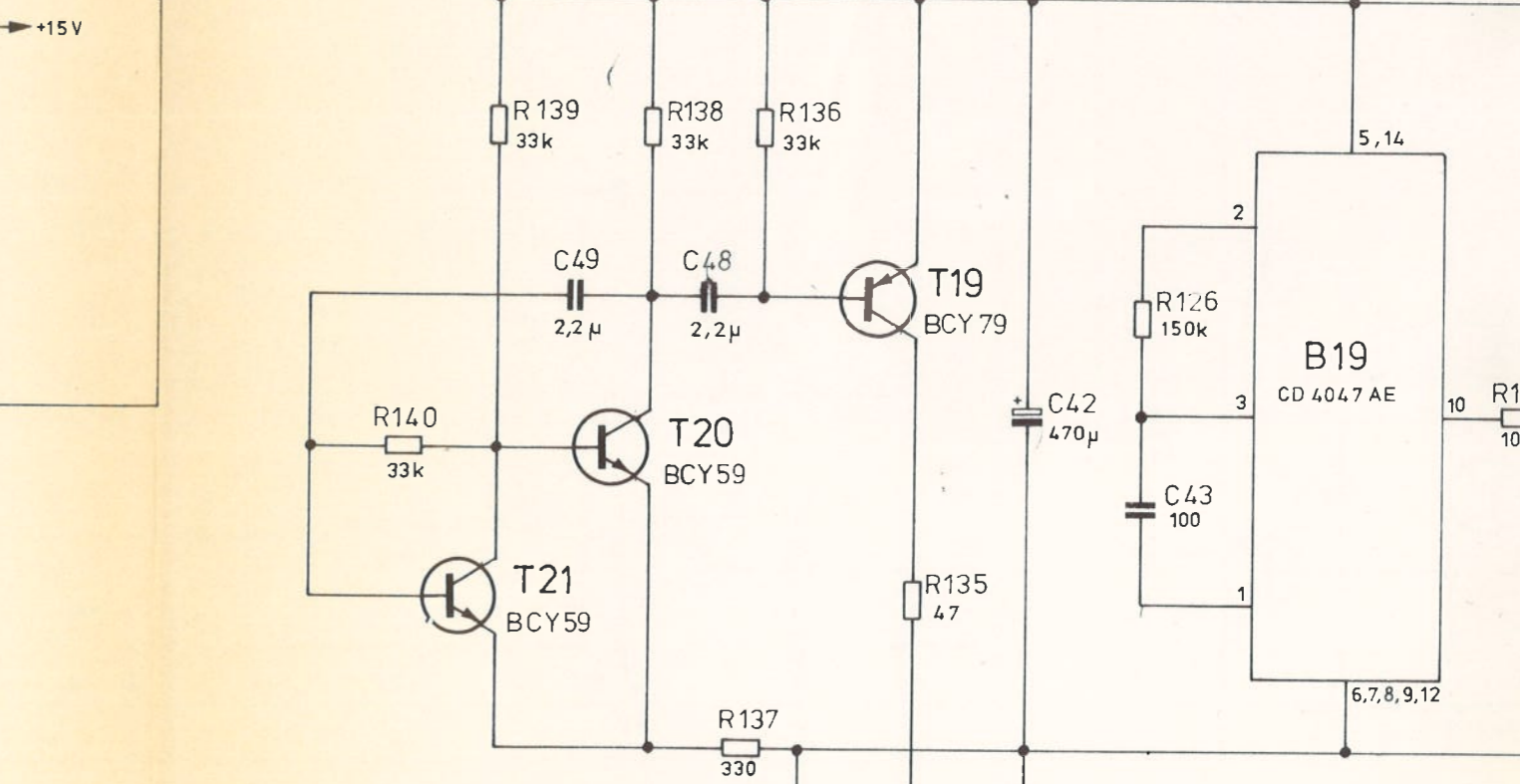
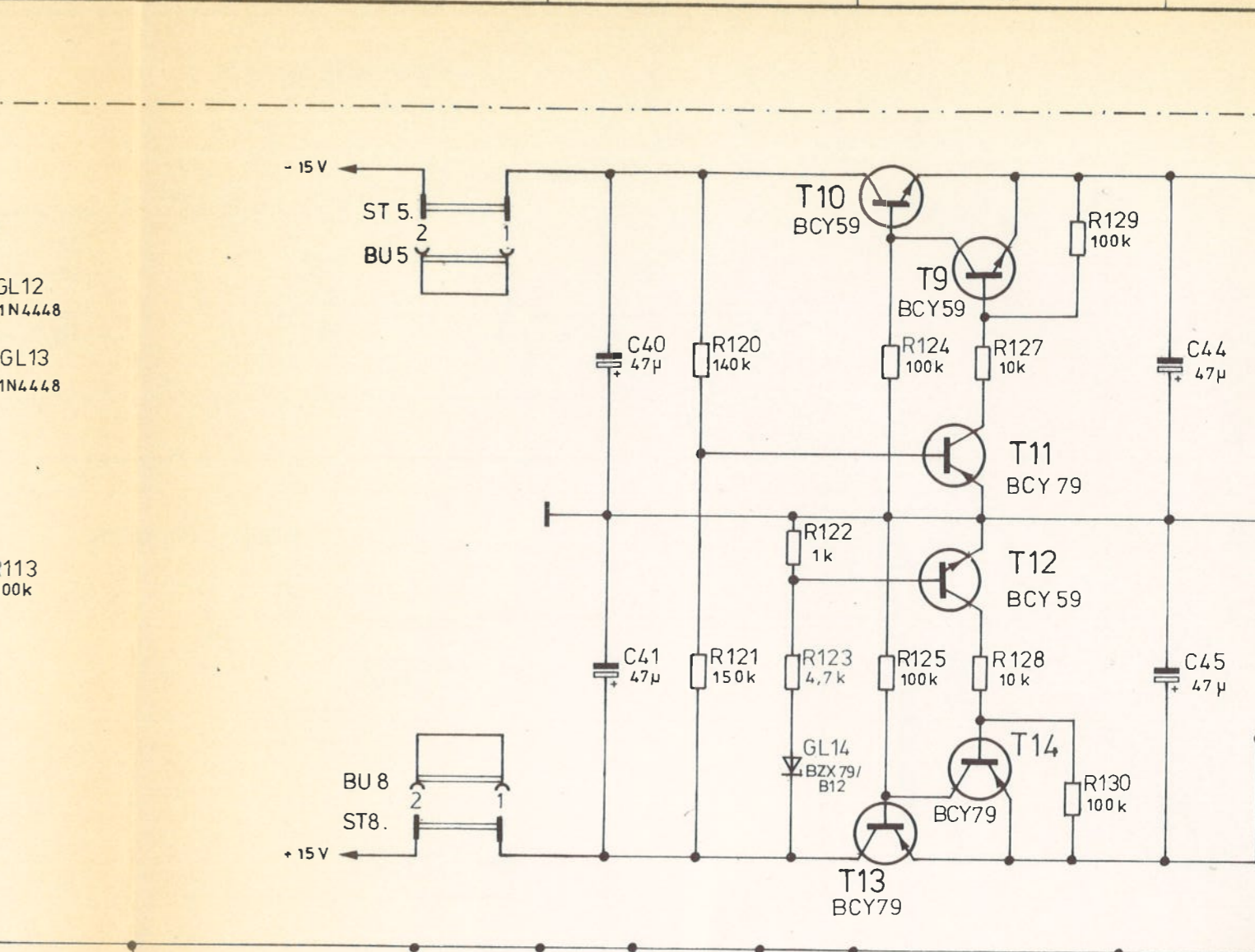
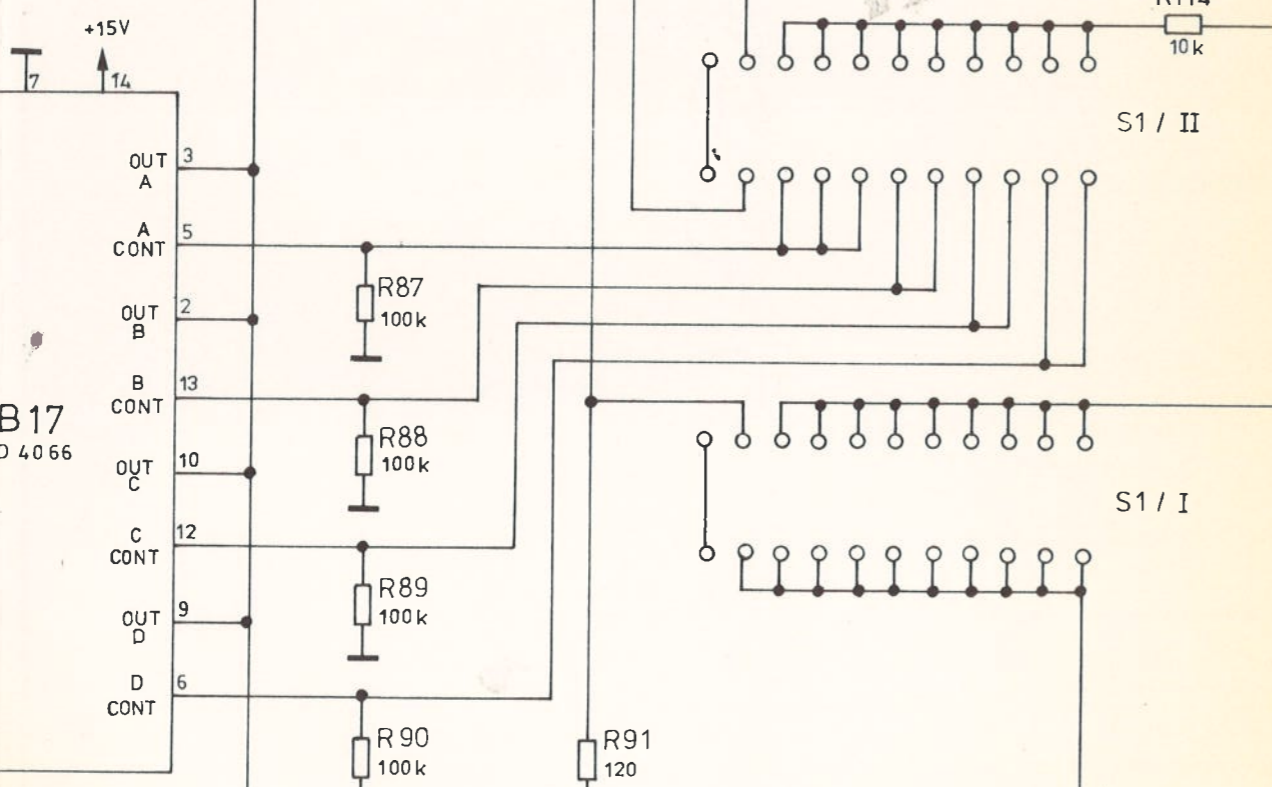
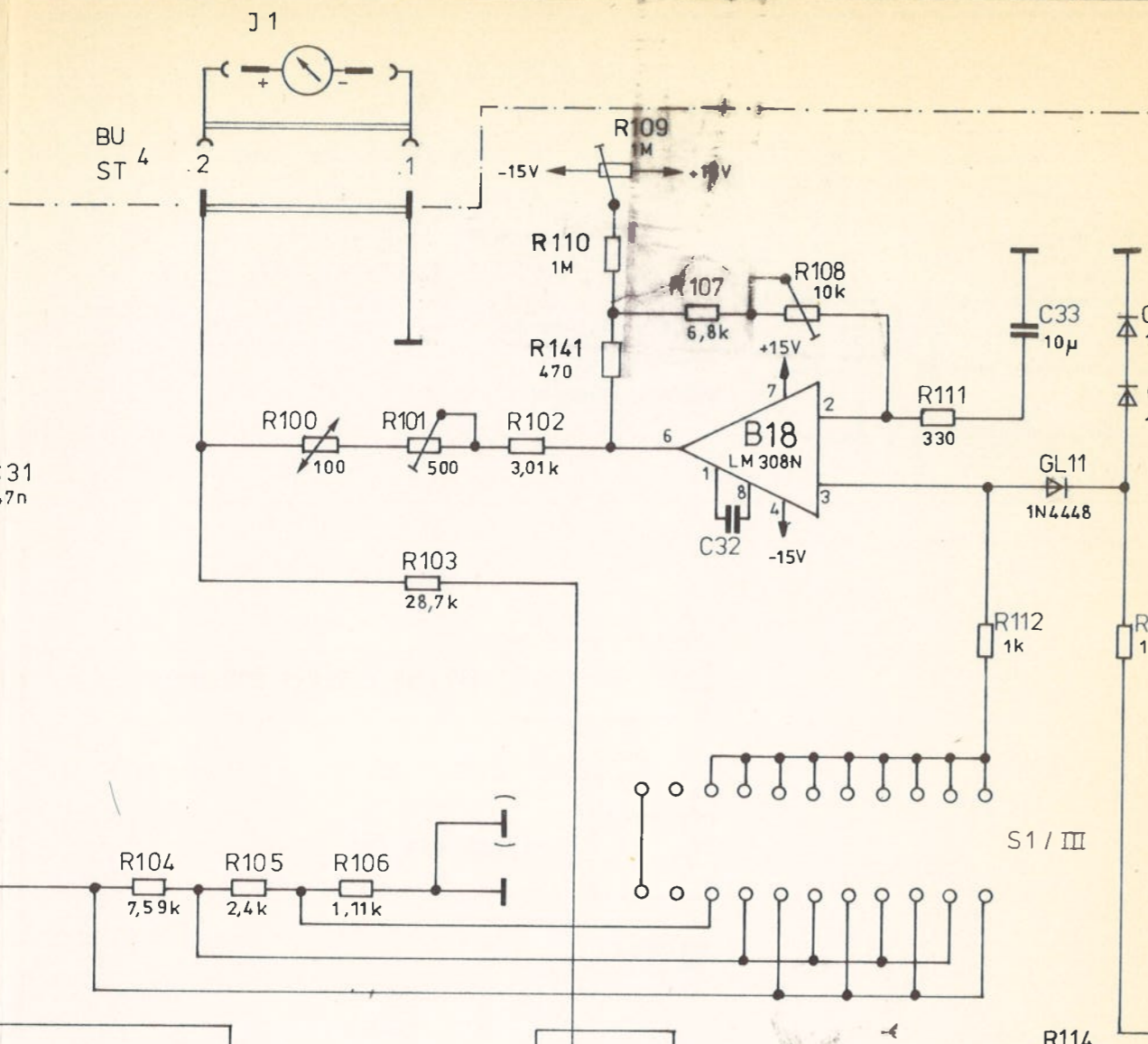
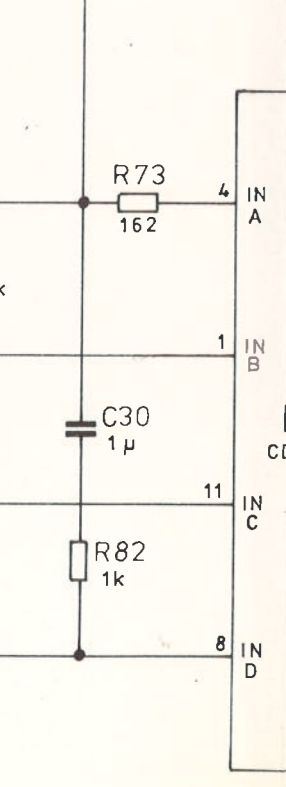
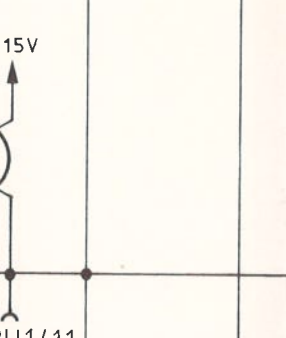
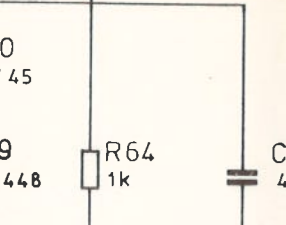
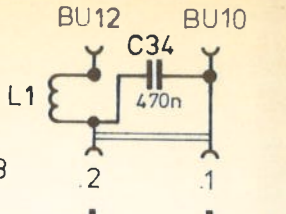

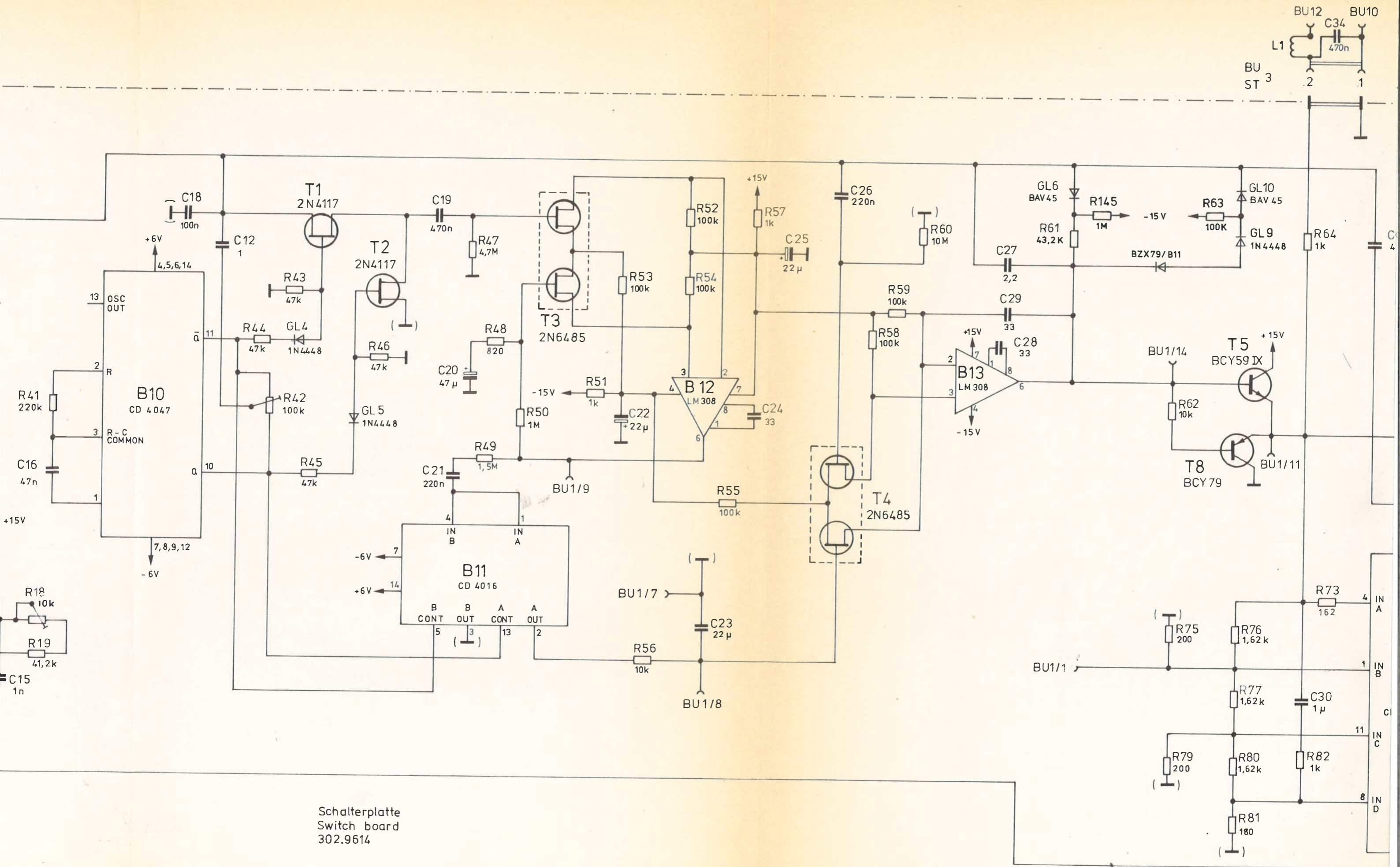

Schalterplatte  
Switch board  
302.9614

And. zuef.	And. zuef.	And. zuef.	And. zuef.	And. zuef.	And. zuef.
And. Nr.	And. Nr.	And. Nr.	And. Nr.	And. Nr.	And. Nr.
Name	Name	Name	Name	Name	Name
Datum	Datum	Datum	Datum	Datum	Datum
And. zuef.	And. zuef.	And. zuef.	And. zuef.	And. zuef.	And. zuef.
And. Nr.	And. Nr.	And. Nr.	And. Nr.	And. Nr.	And. Nr.
Name	Name	Name	Name	Name	Name
Datum	Datum	Datum	Datum	Datum	Datum
And. zuef.	And. zuef.	And. zuef.	And. zuef.	And. zuef.	And. zuef.
And. Nr.	And. Nr.	And. Nr.	And. Nr.	And. Nr.	And. Nr.
Name	Name	Name	Name	Name	Name
Datum	Datum	Datum	Datum	Datum	Datum

Diese Zeichnung ist unter Eigentum Vervielfältigung, auszugsweise Vervielfältigung, Mitteilung an andere ist strafbar und schadenstiftend.

ROHDE & SCHWARZ · MÜNCHEN

1 GME						
gezeichnet	1.6.78	Hg	A	24.88	10.78	He
bearbeitet	78	He	B	24.820	02.79	He
geprüft			C	27621	12.81	Wk
normiert			D	30053	3.83	Li

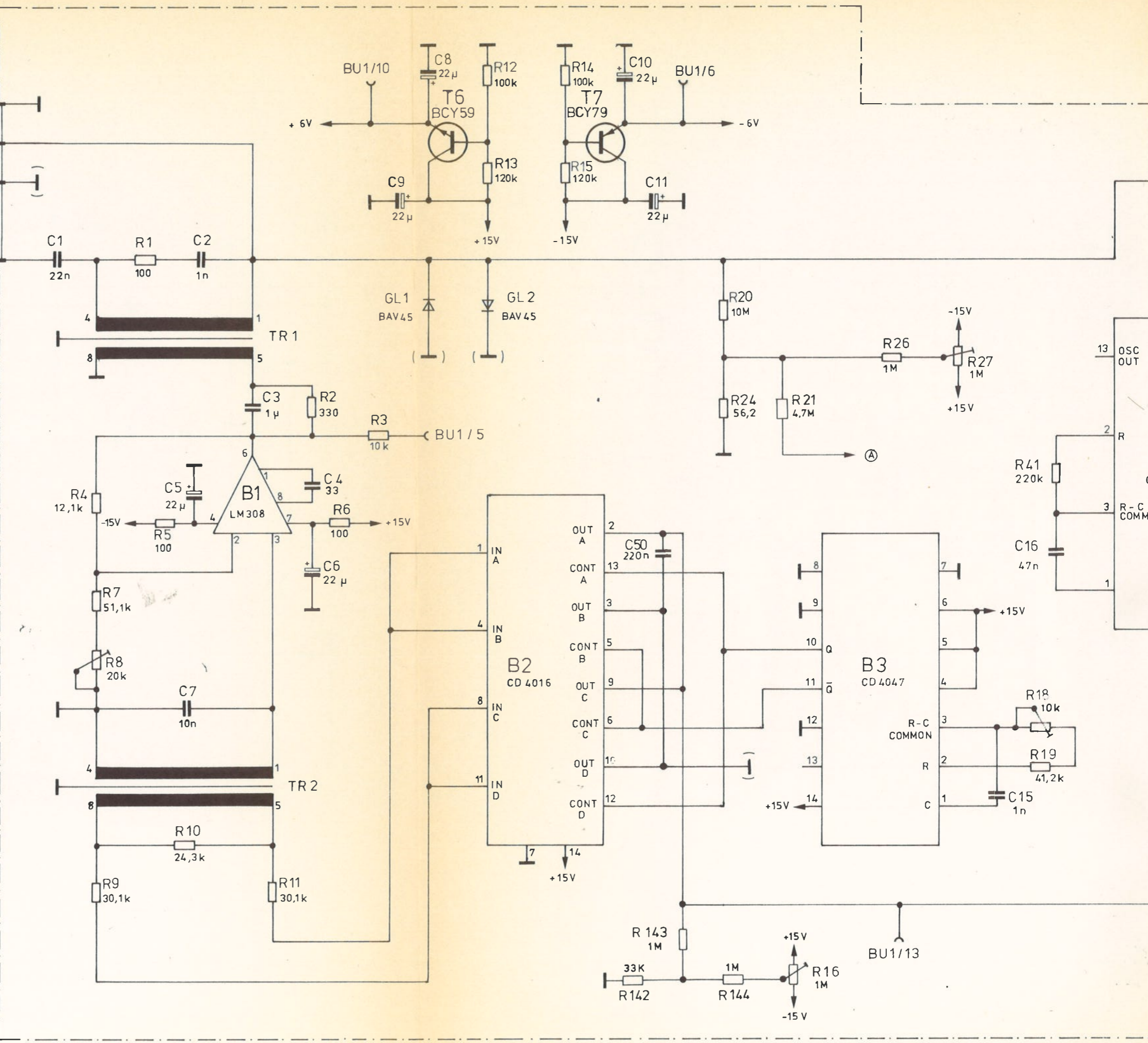
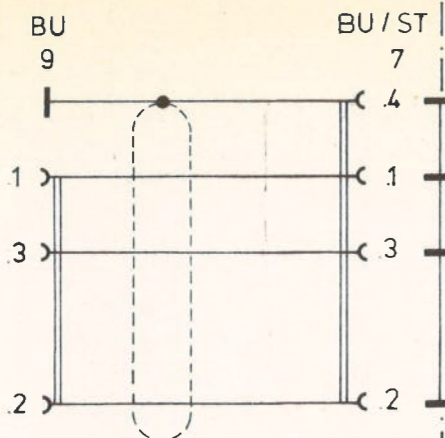

**ROHDE & SCHWARZ**
 ÄZ Datum  
 Date  
 04 0484

 Schalteilliste für  
 Parts list for  
 URV-28 HF-TASTKOPF  
 RF-PROBE

 Sachnummer  
 Stock No.  
 302.9020.01 SA

 Blatt  
 Page  
 1

Kennzeichen Component No.	Benennung/Beschreibung Designation	Sachnummer Stock No.	enthalten in contained in
BU1	FP EINLOETBUCHSE SOCKET BINDER 08-0090-0036	470.6447	243.9101
BU2	FR IC-FASSUNG 14POL. IC SOCKET 14-POLE AUGAT 714-AG1D	FR 155.0926	243.8828
BU3	FP EINLOETBUCHSE SOCKET BINDER 08-0090-0036	470.6447	243.9101
BU4	FR IC-FASSUNG 14POL. IC SOCKET 14-POLE AUGAT 714-AG1D	FR 155.0926	243.8828
BIS/TO BU8 BU9	FP EINLOETBUCHSE SOCKET BINDER 08-0090-0036	470.6447	243.9101
C1	CC 680PF+50-20%5R4000 CERAMIC CAPACITOR DRALORIC SEFK5/680/2050R4000	CC 022.4850	243.9101
C2	CC 1NF+-10%100V3K1200CHIP CAPACITOR VITRAMON VJ1005Y102KFB	CC 082.3221	243.8828
C3	CC 1NF+-10%100V3K1200CHIP CAPACITOR VITRAMON VJ1005Y102KFB	CC 082.3221	243.8828
C4	CC 22NF+-10%50VK1200VIELS CAPACITOR AEROVOX CKR 05 BX 223 K L	CC 060.2445	243.8828
C6	CC 100PF+-10%100V3NPO CHI CAPACITOR VITRAMON VJ1005A101KFB	CC 082.3109	243.8828
GL1	HF-DIODEN-QUARTETT DIODE QUAD	243.9076	243.8828
K1	KABEL CABLE	243.9018	
L1	DROSSEL CHOKE	243.9024	243.8828
L2	DROSSEL CHOKE	243.9024	243.8828
R1	RL 0,21W 10,0KOHM+-1%TK50 RESISTOR RESISTA MK1 10K0 1% TK50	RL 092.1567	243.8828
R2	RL 0,21W 10,0KOHM+-1%TK50 RESISTOR RESISTA MK1 10K0 1% TK50	RL 092.1567	243.8828
R3	RL 0,21W 182 OHM+-1%TK50 RESISTOR RESISTA MK1 1820HM 1% TK50	RL 092.1350	243.8828
R4	RL 0,21W 182 OHM+-1%TK50 RESISTOR	RL 092.1350	243.8828

302.9020 01 SA BL 1+

Für diese Unterlage behalten wir  
uns alle Rechte vor



**ROHDE & SCHWARZ**

ÄZ Datum  
Date

04 0484

Schaltteilliste für  
Parts list for  
**URV-Z8 HF-TASTKOPF**  
**RF-PROBE**

Sachnummer  
Stock No.

302.9020.01 SA

Blatt  
Page

2

Kennzeichen Component No.	Benennung/Beschreibung Designation	Sachnummer Stock No.	enthalten in contained in
	RESISTA MK1 1820HM 1% TK50		- ENDE -

302.9020 01 SA BL 2-

Ansicht und Leitungsführung Bauteilseite  
View of tracks on component side

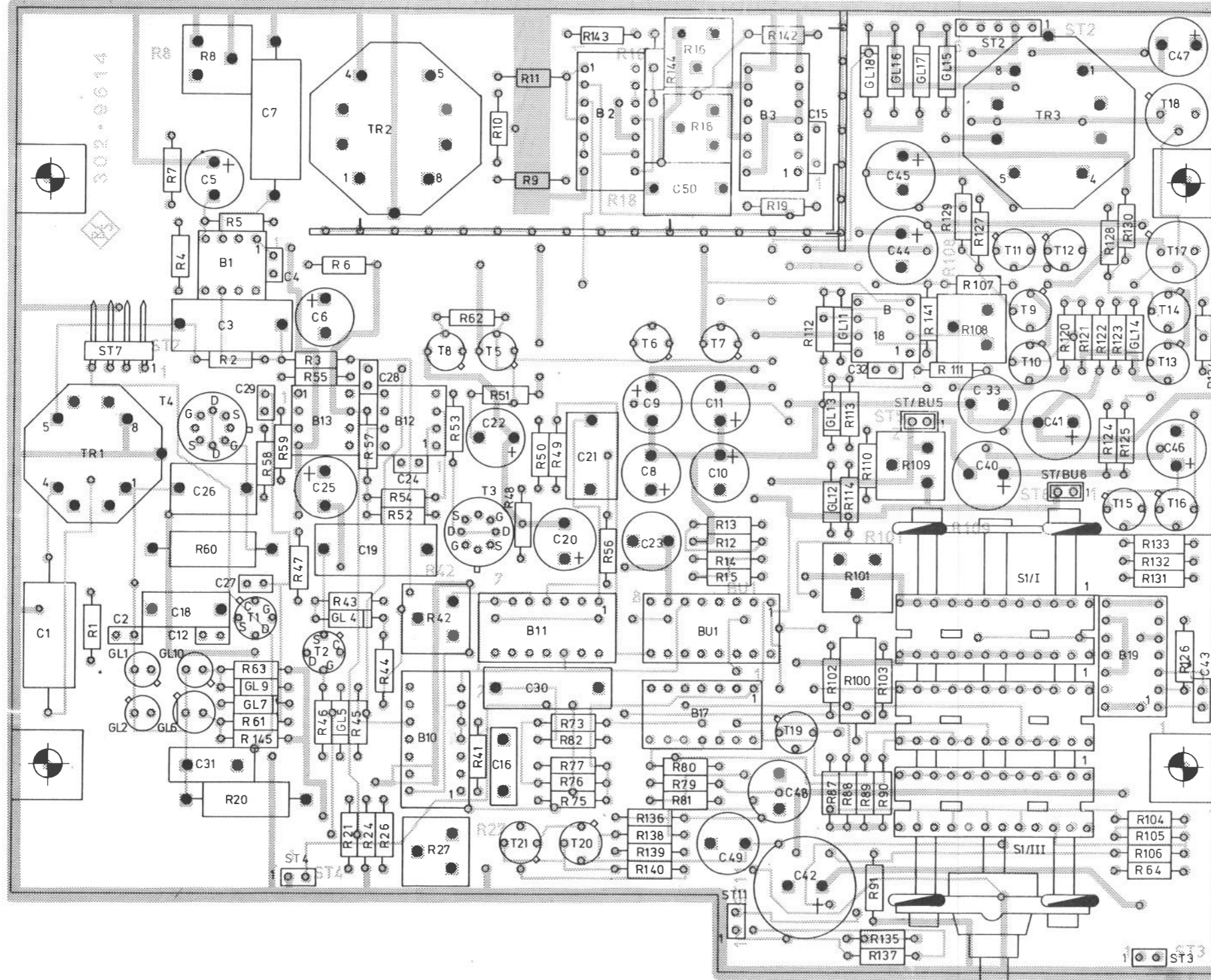

Verfasser		Tag		Name		Benennung		
B	24542	11.78	He	Maße ohne Toleranzangabe		Maßstab		
C	24820	02.79	He	IGME		Halbzeug Werkstoff		
D	25910	02.80	He	Bearb.	6.6.78	Wm.	Schalterplatte	
				Gepr.				Z
				Norm				
And. Zust.		Änderungs-Mitteilung		Tag		Name		
				Zu Gerät		URV3		
				reg. - V		302.9014V		
				erste Z		302.9014		
				Blatt-Nr		2		
				v. Bl.				

Für Masse 2 mm Nut, 2 mm Haken, 2 mm alle Bauteile, etc.

Ansicht und Leitungsführung Lötseite  
View of tracks on solder side

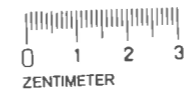
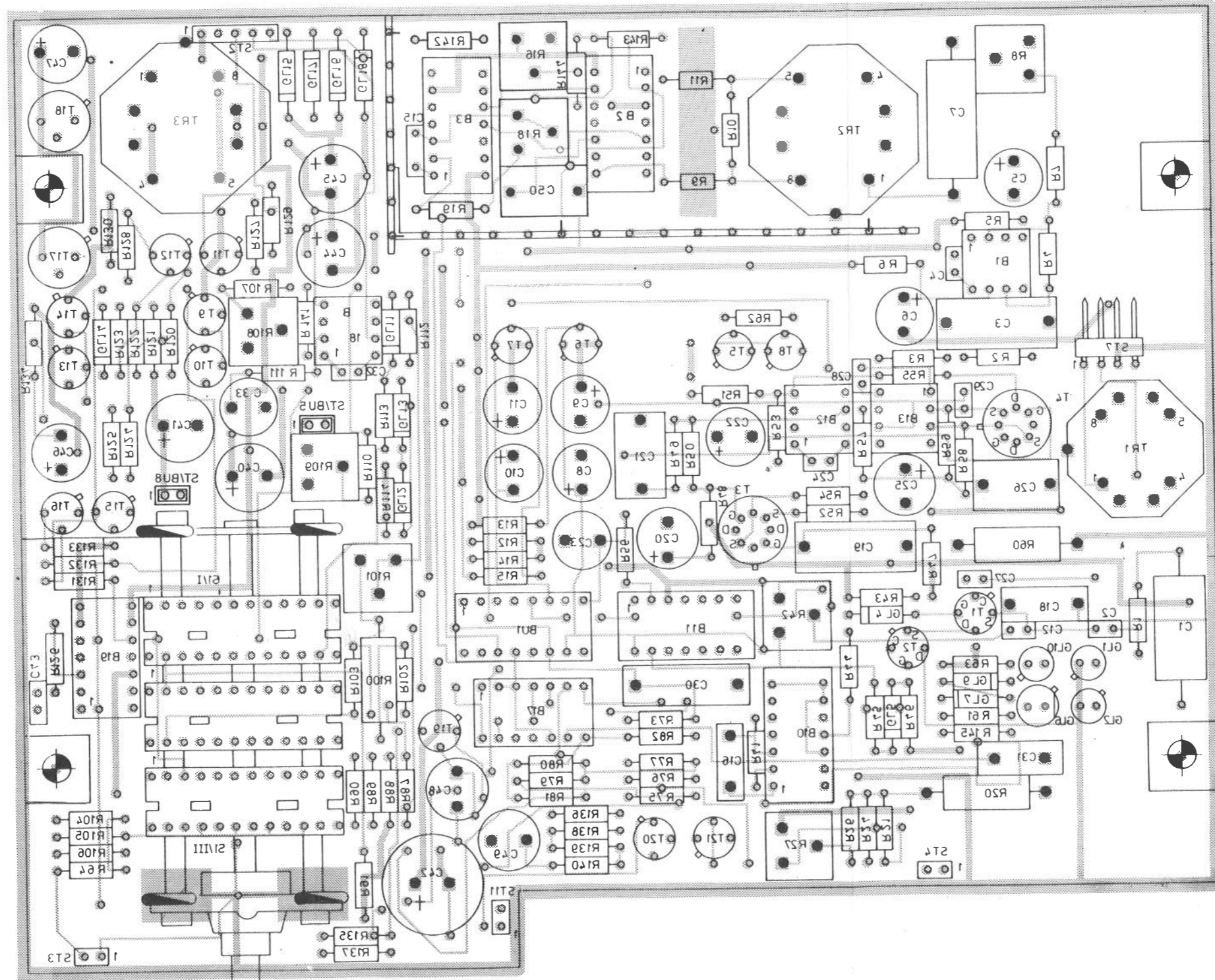

Version Nr.		20. 542		11.78		He		Maße ohne Toleranzangabe		Maßstab	
B		24.820		02.79		He		IGME Tag Name		Halbzeug, Werkstoff	
C		25.910		02.80		He		Bearb. 6.6.78 Wm.		Benennung	
D								Gepr.		Schalterplatte	
								Norm.		Z	
And. Zust.		Anderungs-Mitteilung		Tag		Name		ROHDE & SCHWARZ MÜNCHEN		Blatt-Nr. 3	
								zu Gerät URV 3		Blatt-Nr. 302.9614	
								reg. v. 302.9014 V		erste Z. 302.9014	



Ansicht und Leitungsführung Bauteilseite  
View of tracks on component side

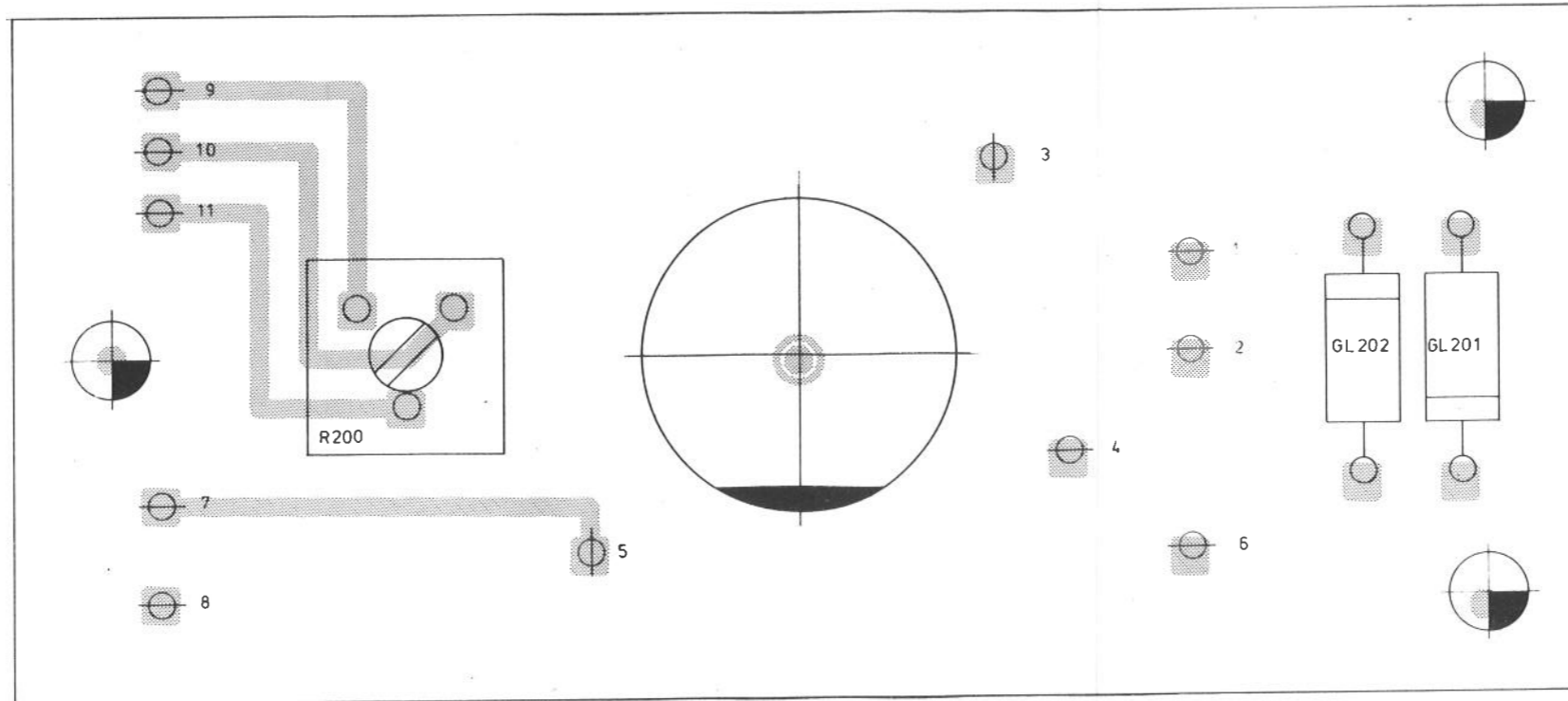

Ansicht und Leitungsführung Lötseite  
View of tracks on solder side

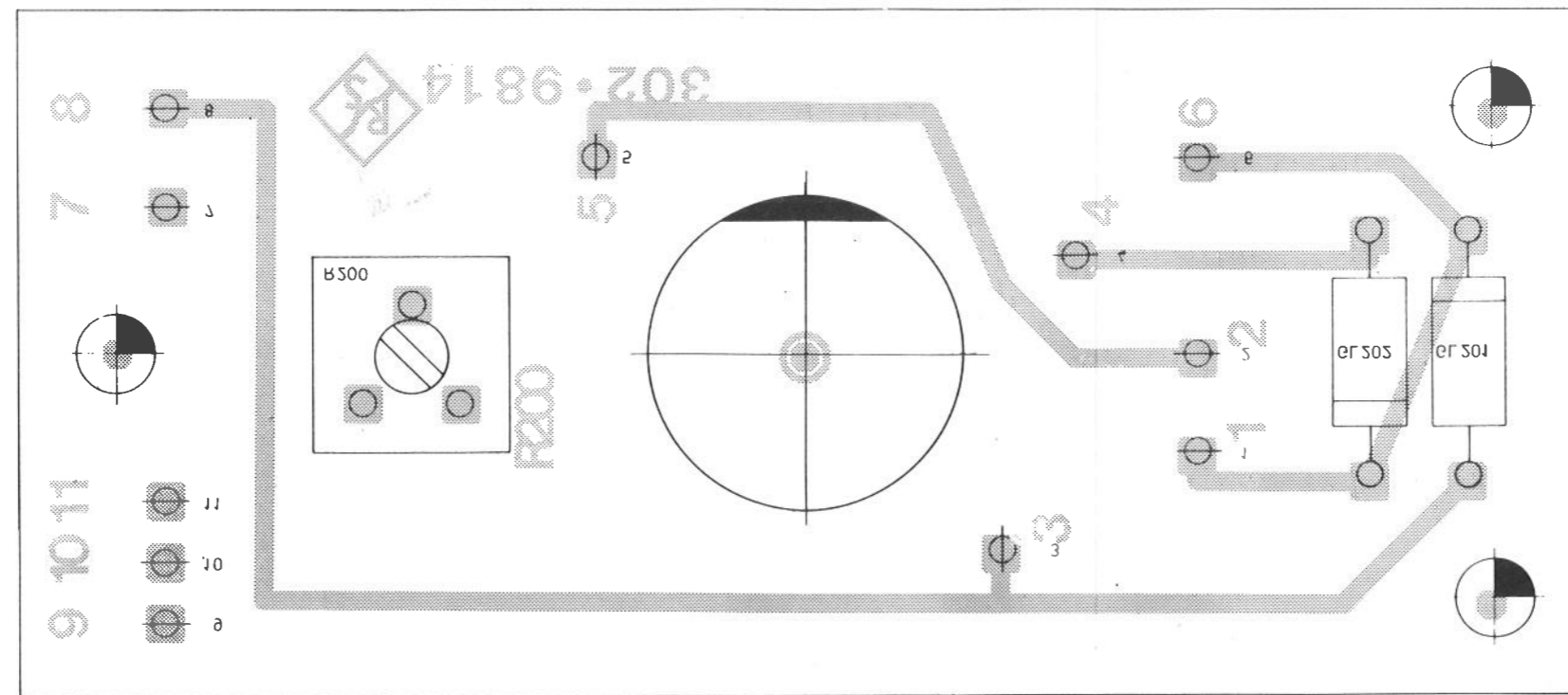

A		24488	10.78	He	Maße ohne Toleranzangabe		Maßstab	
							Halbzeug Werkstoff	
					IGME	Tag	Name	Benennung
					Bearb	5.6.78	Wm	Batterieplatine
					Gepr			Z
					Norm			
					ROHDE & SCHWARZ MÜNCHEN		Zeichn.-Nr	
							302.9814	
					zu Gerät URV 3		reg. v	Blatt-Nr
							302.9014V	2
							erste Z	BI
							302.9014	